

REVOLVE Range Product Catalogue

OFFICE & COMMERCIAL | OUTDOOR | INDUSTRIAL





Contents

<u>ABOUT REVOLVE</u>	01
<u>PRODUCT RANGE OVERVIEW</u>	02
<u>OFFICE & COMMERCIAL</u>	03-24
REVOLVE120 Office Lighting Panel	03-05
REVOLVE120 IP44 Lighting Panel	06-08
REVOLVE120 Suspension Luminaire	09-12
REVOLVE120 COB Downlight and Spotlight	13-15
REVOLVE120 COB IP54 Downlight and Spotlight	16-18
REVOLVE120 Downlight	19-21
REVOLVE120 Batten	22-24
<u>OUTDOOR</u>	25-33
REVOLVE120 Floodlight	25-27
REVOLVE120 All-in-one Solar Streetlight	28-33
<u>INDUSTRIAL</u>	34-42
REVOLVE120 Waterproof Luminaire	34-36
REVOLVE120 Bulkhead Luminaire	37-39
REVOLVE120 Highbay	40-42



REVOLVE

REVOLVE, a brand from Cooper Lighting Solutions, is developed specifically for the Middle East market. The REVOLVE portfolio is designed to meet the needs of lighting projects in the region and caters to a variety of applications; office lighting, commercial buildings, industrial facilities, back-of-house lighting, solar street lighting, retail and hospitality lighting, and outdoor area lighting.

REVOLVE offers an extensive range of indoor and outdoor lighting products, featuring benefits such as energy efficiency, reliability, and excellent aesthetics. These products are designed to minimize energy consumption, helping customers to reduce their energy costs, while being built to last for a long lifetime. The products are designed to complement interior and exterior design styles, making them suitable for functional lighting requirements.

REVOLVE products offer great value for money. The portfolio features and benefits make it a trusted lighting solution, setting the standard for excellence, both in terms of quality and trustworthiness.

Product Range Overview



REVOLVE120
Office Lighting Panel



REVOLVE120
IP44 Lighting Panel



REVOLVE120
Suspension Luminaire



REVOLVE120
Batten



REVOLVE120
COB Downlight and Spotlight



REVOLVE120
COB IP54 Downlight and Spotlight



REVOLVE120
Downlight

OFFICE & COMMERCIAL



REVOLVE120
Floodlight

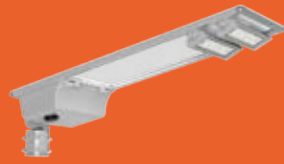

REVOLVE120
All-in-one Solar Streetlight

OUTDOOR



REVOLVE120
Waterproof Luminaire



REVOLVE120
Bulkhead Luminaire



REVOLVE120
Highbay

INDUSTRIAL



**REVOLVE120
Office Lighting Panel**

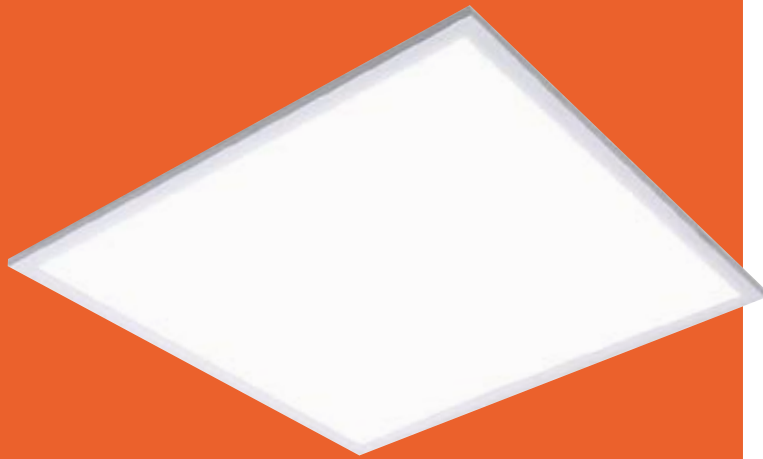

REVOLVE120 Office Lighting Panel

Efficient, Long-lasting and Durable Solution for Office Lighting

Revolve120 office lighting panel adopts a slim profile back-lit technology design, which is suitable for various ceiling types. The product has high-efficiency and high-brightness optical performance, no video flicker and comes with multiple accessory options. The panel is an ideal solution for the replacement of traditional office lighting panels.

Recessed office LED luminaire for general lighting and indoor commercial applications



Applications

- Office Areas
- Healthcare Applications
- Meeting Rooms
- Residential and Commercial Lighting

Features and Benefits

Lightweight and Slim Profile

Slim profile design with external driver and 34mm thickness. It is suitable for various ceiling and spaces.

Easy Installation

Comes with multiple accessory options. Suitable for lay-in ceiling, gypsum board, integrated ceiling, suspension.

Visual Comfort

Flicker free and comfortable lighting experience with excellent glare rating.

Reliable Quality

Consistent lighting performance and long service lifetime (50,000 hours L60B50 @25°C).

Slim Profile Backlit Panel

Energy Efficient

Visual Comfort

Multiple Size Options

Technical Specifications

	Specifications
Size (LxWxH) (mm)	595x595x34mm / 1195x295x34mm / 1195x595x34mm
Beam Angle	120°
Wattage ±10%	40W/48W
Lumen Output ±10%	3700lm/4900lm
Efficacy (lm/w) ±10%	>92lm/W (60x60), 102 lm/W (Large Size)
Color Temperature	CW (6500K)/NW(4000K)
Color Difference	SDCM ≤ 5
Color Rendering	CRI>80
UGR	<22
Input Voltage ±10%	220-240V,50/60H
Power Factor	>0,9
Surge Protection (D/C)	1KV
Insulation Class	ClassII
Driver	External
Applicable Ambient Temperature	-10°C to +35°C
Color	RAL9003
Lifetime	50,000 hours (L60B50) @25°C
Installation Method	VPC, Plasterboard, Suspended, IntegratedCeiling
Certification	CB, EMC
Glow Wire Rating	650° C

*Data subject to change

Product Information

Model	Color Temperature	InstallationMethod	Size
Revolve120 PNL 37S/840 6060	4000K	VPC / Lay-in ceiling	595x595 mm
Revolve120 PNL 37S/865 6060	6500K	VPC / Lay-in ceiling	595x595 mm
Revolve120 PNL 37S/840 30120	4000K	VPC / Lay-in ceiling	295x1195 mm
Revolve120 PNL 37S/865 30120	6500K	VPC / Lay-in ceiling	295x1195 mm
Revolve120 PNL 49S/840 60120	4000K	VPC / Lay-in ceiling	595x1195 mm
Revolve120 PNL 49S/865 60120	6500K	VPC / Lay-in ceiling	595x1195 mm
Optional Accessories/ Installation Kit			
Revolve120 SMB-PLC (PCV Clips 4 Set)	1 set of 4		
Revolve120 SME-2 (Suspension Mounting - 2pcs)	1set of 2		
Revolve120 SC (Safety Cable)	1set of 1		
Revolve120 SMB W60L60 H7 (Surface Mount Bracket)	1 set 1set		
Revolve120 SMB W30L120 H7 (Surface Mount Bracket)	1 set 1set		

*Data subject to change

Mounting Options

- Standard: Visible Profile Ceiling Mounting (VPC)
- Optional: Concealed Profile Ceiling
- Options via Accessories: Built-In Plasterboard
- Options via Accessories: Hanging





**REVOLVE120
IP44 Lighting Panel**

IP44
Front

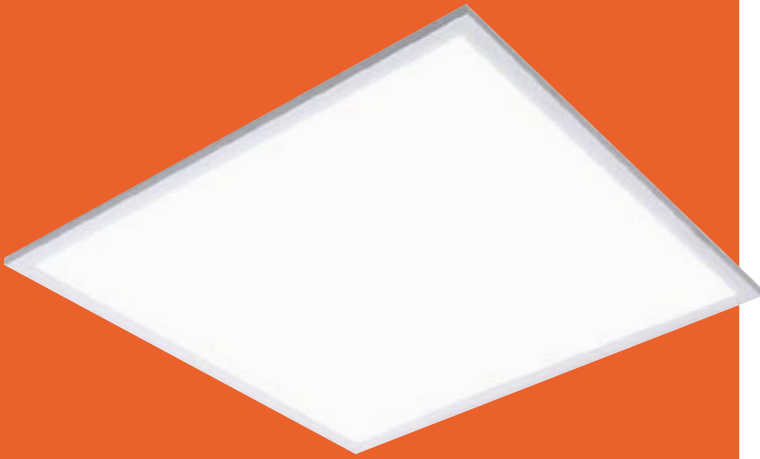

REVOLVE120 IP44 Lighting Panel

IP44
Front

Efficient, Long-lasting and Durable Solution for Office Lighting with IP44 front

Revolve120 office lighting panel adopts a slim profile back-lit technology design, which is suitable for various ceiling types. The product has high-efficiency and high-brightness optical performance, no video flicker, IP44 front and comes with multiple accessory options. The panel is an ideal solution for the replacement of traditional office lighting panels.

Recessed office LED luminaire for general lighting and indoor commercial applications



Applications

- Office Areas
- Healthcare Applications
- Meeting Rooms
- Residential and Commercial Lighting
- Back of house areas

Features and Benefits

Lightweight and Slim Profile

Slim profile design with external driver and 34mm thickness. It is suitable for various ceiling and spaces.

Easy Installation

Comes with multiple accessory options. Suitable for lay-in ceiling, gypsum board, integrated ceiling, suspension.

Visual Comfort

flicker free and comfortable lighting experience with excellent glare rating.

Reliable Quality

Consistent lighting performance and long service lifetime (50,000 hours L60B50 @25°C).

IP44 Front

IP44 rating from the front of the fixture for general indoor lighting applications and back of house area lighting.

Slim Profile Backlit Panel

Energy Efficient

Visual Comfort

IP44 Front

Technical Specifications

	Specifications
Size (LxWxH) (mm)	595x595x34mm
Beam Angle	120°
Wattage	34W
Lumen Output ±10%	4100 lm
Efficacy (lm/w)±10%	120 lm/W
Color Temperature	CW (6500K)/NW(4000K)
Color Difference	SDCM ≤ 5
Color Rendering	CRI>80
UGR	<22
Input Voltage ± 10%	220-240V,50/60H
Power Factor	>0.9
Surge Protection (D/C)	1KV
Insulation Class	ClassII
IPXX Rating	IP44 (front) / IP20
Driver	External
Applicable Ambient Temperature	-1 0°C ~+35°C
Color	RAL9003
Lifetime	50,000Hours (L60B50) @25°C
Installation Method	VPC, Plasterboard, IntegratedCeiling
Certification	CB, EMC
Glow Wire Rating	650° C

*Data subject to change

Product Information

Model	Color Temperature	InstallationMethod	Size
REVOLVE120 PNL IP44 41S/840 6060	4000K	VPC / Lay-in ceiling	595x595 mm
REVOLVE120 PNL IP44 41S/865 6060	6500K	VPC / Lay-in ceiling	595x595 mm

*Data subject to change

Mounting Options

- Standard: Visible Profile Ceiling Mounting (VPC)
- Optional: Concealed Profile Ceiling
- Options via Accessories: Built-In Plasterboard

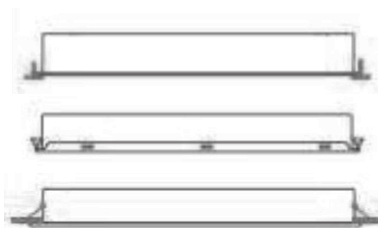

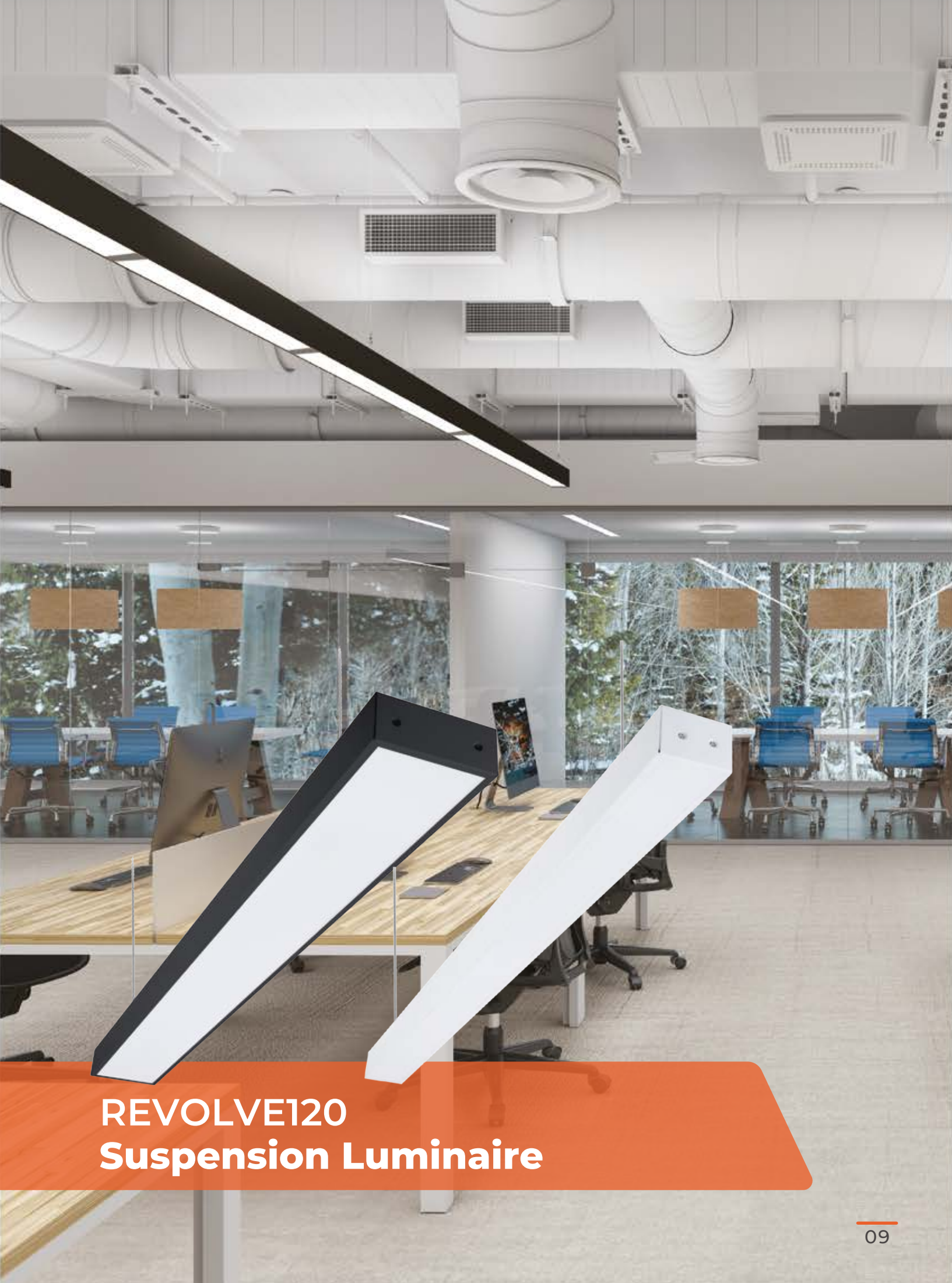

**REVOLVE120
Suspension Luminaire**



REVOLVE120 Suspension Luminaire

Robust Wall & Ceiling Mounted Luminaire

REVOLVE120 Suspension luminaire reflects a contemporary design and simplicity for a stylish look and feel. It's high efficiency LED technology results in >50% energy savings as compared to the conventional luminaire. This suspension mounted luminaire can be installed independently or continuously, with uniform light color, softness and comfort of a glare-free and flicker-free lighting.

Features and Benefits

Stylish Look & Feel

Sleek and Elegant product design with differing product width/length options. Available in 3 different sizes (width: 70mm, 100 mm, 120 mm and length: 600mm, 1200mm) with slim profile suspension mounting accessories.

Excellent Uniformity

Uniform light distribution with low glare and comfortable lighting.

High Efficacy

High CRI >80 with excellent efficacy of >90 lm/W with long lifetime of 50,000 hours.

Flexible and Versatile

Suspension mounting with multiple accessory options to join the luminaires for continuous mounting and adjust product height as per need.

Flicker Free

Flicker free for better visual comfort.

Stylish and energy-efficient suspension mounted luminaire for office areas, meeting rooms and general area lighting for commercial spaces.



Applications

- Office Lighting
- Meeting Rooms
- Reception Areas
- Indoor Commercial Spaces
- General Indoor Area Lighting

Energy Efficient

Multiple Width Options

Black and White Body Color

Stylish Look and Feel

Technical Specifications

	Specifications
Lumen output (Typ.Avg) (±10%)	W12L1200 – 3000lm / W12L600 – 1500lm W07L1200 – 2600lm / W07L600 – 1300lm; W10L1200 - 2900lm
CRI	≥80
CCT	4000K/6500K
SDCM	≤5
Input Voltage and Frequency	220-240VAC, 50/60hz
Safety Class (Driver+System)	Class I
Power Factor (System)	>0.9
Power consumption (System) (±10%)	W12L1200 – 34W / W12L600 – 16W W07L1200 – 28W / W07L600 – 14W ; W10L1200 -32W
System Efficacy (±10%)	88-93lm/W
THD	<30%
Surge Protection	L600:0.5KV/1KV; L1200:1KV/2KV
Material	Housing: SPCC ; Diffuser: PC
IP/IK	IP20 / IK02
Mounting	Suspended
Color(s) (and RAL code)	White ; Dark Grey
Size (LxWxH) + Considerations	L600xW120xH50;L1200xW120xH50;L600xW70xH50; L1200xW70xH50;L1200xW100xH50;
Packaging Concept	2 in 1 with brown box, no inner box
Lifetime	50,000hrs L65B50 @Ta 25°C
Approbation	CB/EMC
Accessory	Suspension Kit & Joining Kit (separate codes to be ordered)

*Data subject to change

Product List

Product Description
REVOLVE120 RNS 13S/865 0760 BK
REVOLVE120 RNS 13S/840 0760 BK
REVOLVE120 RNS 26S/865 07120 BK
REVOLVE120 RNS 26S/840 07120 BK
REVOLVE120 RNS 15S/865 1260 BK
REVOLVE120 RNS 15S/840 1260 BK
REVOLVE120 RNS 30S/865 12120 BK
REVOLVE120 RNS 30S/840 12120 BK
REVOLVE120 RNS 29S/865 10120 BK
REVOLVE120 RNS 13S/865 0760 WH
REVOLVE120 RNS 26S/840 07120 WH
REVOLVE120 RNS 15S/840 1260 WH
REVOLVE120 RNS 15S/865 1260 WH
REVOLVE120 RNS 30S/865 12120 WH
REVOLVE120 RNS 30S/840 12120 WH
REVOLVE120 RNS 29S/865 10120 WH
REVOLVE120 RNS 29S/840 10120 WH

*Data subject to change

Accessories

Suspension Kit (Optional)

REVOLVE120 RNS Suspending accessory



Connection / Joining Kit (optional)

REVOLVE120 RNS connection W07

REVOLVE120 RNS connection W10

REVOLVE120 RNS connection W120



Product Dimensions

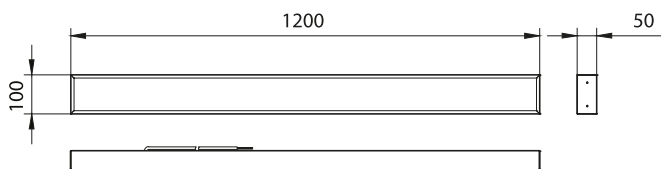
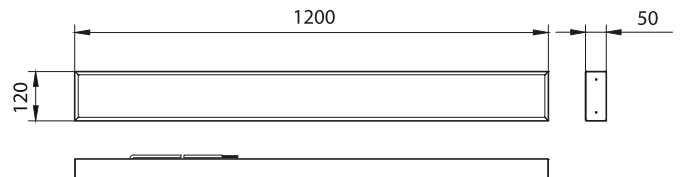
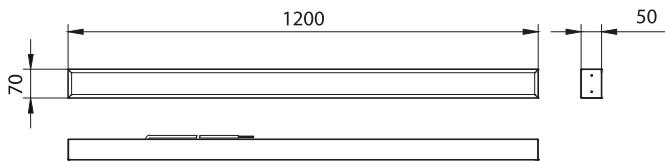
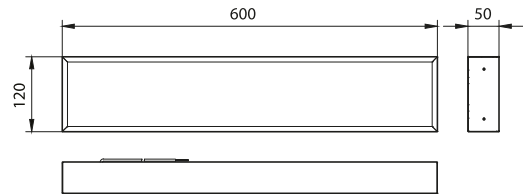
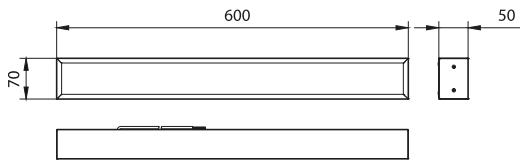



**REVOLVE120
COB Downlight and Spotlight**

REVOLVE120 Spotlight



REVOLVE120 Downlight Range



REVOLVE120 COB Downlight and Spotlight

REVOLVE120 Spotlight and Downlight family has professional COB optical design, with an elegant appearance and sustainable performance. Because of its multiple cutout options (70/100/150/200mm) it is the right solution for a variety of applications ranging from retail to commercial. The new REVOLVE120 has an efficacy of up to 105 lm/W making it more than 50% energy efficient than conventional lighting. It has a color rendering index of >80 with crisp lighting effect and high quality aluminum body which makes it the ideal lighting solution.

Professional spotlight and COB downlight range for robust, reliable and energy efficient lighting needs in commercial spaces.



Applications

- Retail
- Commercial Buildings
- Shopping Mall
- Residential
- Hospitality
- Office Areas

Features and Benefits

Comprehensive Range

Perfect COB downlight and spotlight solution for retail, hospitality and commercial applications with multiple cutout options (70/100/150/200mm).

Energy Efficient and Long Lifetime

High efficacy up to 105 lm/W with lumen choices from 700lm to 4000lm.
Long service lifetime of 50,000 hours.

Attractive Design

Elegant look and feel with front glass plus frosted point and powder coated aluminum body.

High Light Quality

Excellent color rendering with CRI >80.

Up to 4000 Lumens

Front Glass Cover

COB Design

4 Cut-Out Options

Aluminum body

Technical Specifications

	Spotlight		COB Downlight			
	7W	10W	20W	30W	40W	
Power Consumption (System) ±10%	7W		10W	20W	30W	40W
Lumen Output (typ.Avg) (lm) ±10%	665lm@3000K	900lm@3000K	1900lm@3000K	2850lm@3000K	3600lm@3000K	
	700lm@4000K	950lm@4000K	2100lm@4000K	3150lm@4000K	4000lm@4000K	
	700lm@6500K	950lm@6500K	2100lm@6500K	3150lm@6500K	4000lm@6500K	
CRI	>80					
SDCM	(3000K/4000K;<5)					
Beam Angle	110°±10°					
Input Voltage and Frequency	220-240V, 50/60Hz					
Protection Class	Class II					
Fuse or Short-Circuit Protection	Short-Circuit Protection					
Power Factor (System)	0.5	0.5	0.5	0.9	0.9	
System Efficacy (lm/W) ±10%	95lm/w@3000K	90lm/w@3000K	95lm/w@3000K	95lm/w@3000K	95lm/w@3000K	
	100lm/w@4000K	95lm/w@4000K	105lm/w@4000K	105lm/w@4000K	105lm/w@4000K	
	100lm/w@6500K	95lm/w@6500K	105lm/w@6500K	105lm/w@6500K	105lm/w@6500K	
Surge Protection	1KV					
Housing Material	Aluminium + Clear Glass with Frosted point					
Reflector/Lens Material (LG)	Aluminium					
Cover Material (Diffuser)	Aluminium					
Front Protection	Front Glass clear with centr frosting					
Salt Spray	48H for springs and screws					
Mounting	Recessed Installation					
Cut Off Size	φ75-80mm	φ100-110mm	φ140-150mm	φ190-210mm	φ190-210mm	
Power Connection	2×0.75mm ²					
Size (LxWxH) + Considerations	φ90x32mm	φ120×45mm	φ166×45mm	φ225×45mm	φ225×45mm	
Weight (Kg)	150g±10%	235g±10%	390g±10%	680g±10%	680g±10%	
Operating Temperature Range (°C)	-20°C to +40°C					
Operating Relative Humidity Range (%)	RH 0~90°C					
Application Scenarios	Indoor					
Lifetime	50000 Hrs L60B50 @ta25°C					

*Data subject to change

Product List

Product Description	Product Type
REVOLVE120 COB DL LED6/830 PSU D75	Spotlight
REVOLVE120 COB DL LED7/840 PSU D75	Spotlight
REVOLVE120 COB DL LED7/865 PSU D75	Spotlight
REVOLVE120 COB DL LED9/830 PSU D100	COB Downlight
REVOLVE120 COB DL LED10/840 PSU D100	COB Downlight
REVOLVE120 COB DL LED10/865 PSU D100	COB Downlight
REVOLVE120 COB DL LED19/830 PSU D140	COB Downlight
REVOLVE120 COB DL LED21/840 PSU D140	COB Downlight
REVOLVE120 COB DL LED21/865 PSU D140	COB Downlight
REVOLVE120 COB DL LED28/830 PSU D190	COB Downlight
REVOLVE120 COB DL LED31/840 PSU D190	COB Downlight
REVOLVE120 COB DL LED31/865 PSU D190	COB Downlight
REVOLVE120 COB DL LED36/830 PSU D190	COB Downlight
REVOLVE120 COB DL LED40/840 PSU D190	COB Downlight
REVOLVE120 COB DL LED40/865 PSU D190	COB Downlight

*Data subject to change



REVOLVE120
COB IP54 Downlight and Spotlight

IP54
Front

REVOLVE120 Spotlight



REVOLVE120 Downlight Range



REVOLVE120 COB IP54 Downlight and Spotlight

REVOLVE120 Spotlight and Downlight family has professional COB optical design, with an elegant appearance and sustainable performance. Because of its multiple cutout options (75/100/150/200) it is the right solution for a variety of applications ranging from retail to commercial, back of house applications and washroom areas. The new REVOLVE120 has an efficacy of up to 105 lm/W making it more than 50% energy efficient than conventional lighting. It has a color rendering index of >80 with crisp lighting effect and high quality aluminum body which makes it the ideal lighting solution.

Professional spotlight and COB downlight range for robust, reliable and energy efficient lighting needs in commercial spaces.



Applications

- Retail
- Commercial Buildings
- Shopping Mall
- Residential
- Hospitality
- Office Areas
- Corridors & back of house areas
- Kitchen & Washroom areas

Features and Benefits

Comprehensive Range

Perfect COB downlight and spotlight solution for retail, hospitality and commercial applications with multiple cutout options (75/100/150/200).

Energy Efficient and Long Lifetime

High efficacy up to 105 lm/W with lumen choices from 700lm to 3000lm. Long service lifetime of 50,000 hours.

Attractive Design

Elegant look and feel with front glass plus frosted point and powder coated aluminum body.

High Light Quality

Excellent color rendering with CRI >80.

IP54 Front

IP54 from front side / Room side (option in all 04 sizes) makes it one stop solution for commercial building needs (lighting for BOH areas, Kitchen, washrooms, corridors as well as general lighting needs)

Upto 3000 lumens

IP54 Front

COB Design

4 Cut-Out Options

Aluminum body

Technical Specifications

	IP54 Spotlight		IP54 COB downlight	
Power Consumption (System) ±10%	7W		10W	20W
Lumen Output (typ.Avg) (lm) ±10%	665lm@3000K		900lm@3000K	1900lm@3000K
	700lm@4000K		950lm@4000K	2100lm@4000K
	700lm@6500K		950lm@6500K	2100lm@6500K
CRI	>80			
SDCM	(3000K/4000K;<5)			
Beam Angle	110°±10°			
Input Voltage and Frequency	220-240 V, 50/60Hz			
Protection Class	Class II			
Fuse or Short-Circuit Protection	Short-Circuit Protection			
Power Factor (System)	0.5	0.5	0.5	0.9
System Efficacy (lm/W) ±10%			95lm/w@3000K	
			100lm/w@4000K	
			100lm/w@6500K	
Displacement Factor (DF)	0.7	0.7	0.7	0.9
Surge Protection	1KV			
Housing Material	Aluminium + Clear Glass with Frosted point			
Reflector/Lens Material (LG)	Aluminium			
Cover Material (Diffuser)	Aluminium			
Front Protection	Front Glass clear with centr frosting			
IPXX	IP54 front size / IP20 (back side)			
Salt Spray	48H for springs and screws			
Mounting	Recessed Installation			
IKXX	IK 03			
Cut Off Size	φ75-80mm	φ100-110mm	φ140-150mm	φ200mm
Power Connection	2*0.75mm ²			
Size (LxWxH) + Considerations	φ90x32mm	φ120x45mm	φ166x45mm	φ225x45mm
Weight (Kg)	150g±10%	235g±10%	390g±10%	680g±10%
Operating Temperature Range (C)	-20 ~ +40C			
Operating Relative Humidity Range (%)	RH 0~90°C			
Application Scenarios	Indoor			
Lifetime	50000 Hrs L60B50 @ta25°C			

*Data subject to change

Product List

Product Description	Product Type
REVOLVE120 COB DL LED6/830 IP54 D75	IP54 Spot
REVOLVE120 COB DL LED7/840 IP54 D75	IP54 Spot
REVOLVE120 COB DL LED7/865 IP54 D75	IP54 Spot
REVOLVE120 COB DL LED9/840 IP54 D100	IP54 COB Downlight
REVOLVE120 COB DL LED10/865 IP54 D100	IP54 COB Downlight
REVOLVE120 COB DL LED10/830 IP54 D100	IP54 COB Downlight
REVOLVE120 COB DL LED19/830 IP54 D140	IP54 COB Downlight
REVOLVE120 COB DL LED21/840 IP54 D140	IP54 COB Downlight
REVOLVE120 COB DL LED21/865 IP54 D140	IP54 COB Downlight
REVOLVE120 COB DL LED28/830 IP54 D200	IP54 COB Downlight
REVOLVE120 COB DL LED31/840 IP54 D200	IP54 COB Downlight
REVOLVE120 COB DL LED31/865 IP54 D200	IP54 COB Downlight

*Data subject to change



**REVOLVE120
Downlight**



REVOLVE120 Downlight

Elegant Look and Feel With Reliable and Sustainable Performance.

REVOLVE120 downlight family offers a comprehensive range of LED downlights to retrofit conventional fittings and equally good for new installations within a wide range of applications from commercial to residential spaces. The product offers excellent efficacy of >100 lm/w which results in >50% energy savings as compared to the conventional option. It has low flicker, high quality lighting along with recessed installation option and long lifetime enables it to create a more comfortable lighting environment.

Features and Benefits

Comprehensive Range

Wide range of offerings from 9W to 24W for variety of applications. Available in 3 cut-out options.

Energy Efficient and Long Lifetime

Long lifetime of 50,000 hours with a system efficacy of >100lm/W. Energy savings are >50% as compared to the conventional downlight.

Compact Design

Elegant look and feel with a slim profile, compact design and generates a powerful light output from 900lm up to 2650lm.

Bright and Comfortable Lighting

High color rendering (≥ 80) with low flickering results in a comfortable lighting experience.

Diverse range of LED downlights to suit various lighting needs for offices and indoor commercial applications



Applications

- General Area Lighting
- Office Corridors & Spaces.
- Meeting Rooms
- Retail Lighting
- Residential and Commercial Spaces

Up to 2650 Lumens

Diffused Light Output

Low Flickering

3 Cut-Out Options

CE, CB Certifications

Technical Specifications

	9W	18W	24W
Cut-out (mm)	Ø105-115	Ø145-155	Ø195-205
Lumen (lm) @4000K (±10%)	920	1850	2650
CRI	80		
CCT	3000K / 4000K / 6500K		
Beam Angle	105° ±10		
Input Voltage and Frequency	220-240V; 50/60Hz		
Lifetime @Ta +25 deg. C	50000hrs @ L60B50		
Power Factor (system)	>0.5		
Power consumption (system) (±10%)	9W	18W	24W
Max. System Efficacy (lm/W) @4000K	102	103	110
Surge Protection	0.75kV		
Protection class	Class II		
Housing material	Plastic Body		
Cover material (Diffuser)	PS (Diffused Light Output)		
IPxx	IP20		
Ikxx	IK03		
Cable	2*0.75 mm ² , cable length 132.5mm		
Size (LxWxH)	φ125*H45	φ170*H45	φ220*H45
Operating Temperature Range (°C)	-20°C to +40°C		
Mounting	Recessed		

*Data subject to change

Product List

Product Description	Product Type
REVOLVE120 DL LED8/830 PSU D105	9W
REVOLVE120 DL LED9/840 PSU D105	9W
REVOLVE120 DL LED9/865 PSU D105	9W
REVOLVE120 DL LED17/830 PSU D145	18W
REVOLVE120 DL LED18/840 PSU D145	18W
REVOLVE120 DL LED18/865 PSU D145	18W
REVOLVE120 DL LED25/830 PSU D195	24W
REVOLVE120 DL LED26/840 PSU D195	24W
REVOLVE120 DL LED26/865 PSU D195	24W

*Data subject to change



Delicious Food

**REVOLVE120
Batten**



REVOLVE120 Batten

Robust Wall & Ceiling Mounted Luminaire

New generation REVOLVE120 Batten has an elegant design with flexible installation options. Its uniform lighting effect with diffused light output and high color rendering provides excellent ambiance and aesthetics. The product is a direct replacement for conventional battens in terms of performance, installation and flexibility with long service lifetime. It reduces energy cost and optimizes operations making it the perfect solution for hypermarkets, back-of-house lighting and general area lighting needs.

Features and Benefits

Energy Efficient

High efficacy > 120 lm/W with uniform light output. High color rendering >80, reduces energy costs.

Stylish Look and Feel

Elegant & slim design with high lumens up to 6000 lm. Uniform light distribution with complete diffused light output. Ideal for setting up seamless and aesthetic light-lines for warehouses and retail spaces.

Robust and Durable

Robust design with steel body and high quality polycarbonate front cover for diffused light output and visual comfort. Long service lifetime (50K hrs.)

Wide range of applications

Availability in 02 length options and easy to install with sheet metal body making it ideal solution for general area lighting and ambient lighting.

Professional LED batten range for robust, reliable and energy efficient lighting requirements for general indoor area lighting.



Applications

- Hypermarkets / Retail Lighting
- Back of House Lighting
- Assembly Lines
- Warehouses
- General Indoor Area Lighting

Uniform Diffused Lighting

Energy Efficient (>120lm/W)

Sheet Metal Body

CRI >=80

Technical Specifications

	Specifications
Lumen Output (Typ.avg) (Lm) (±10%)	4FT 4000lm / 5FT 6000lm
CRI (Ra&r9)	≥80
CCT(K)	3000K/4000K/6500K
SDCM	≤5
Uniformity	No visible shadow and light dot
Light Outlet (Direct/Indirect)	Direct
Input Voltage and Frequency	220-240V; 50/60Hz
Protection Class	Class I
System Power Factor	>0.95
System Power Consumption (W) (±10%)	4FT: ~33W 5FT: ~50W
System Efficacy (Lm/w) ±10%	120lm/W
Housing Material	Steel Sheet
Cover Material (Diffuser)	Poly carbonate
IPXX	IP20
IKXX	IK02
Mounting Requirement	Ceiling, wall
Color(s) (and RAL Code)	RAL9003 (ΔE<3)
Size (LxWxH) + Considerations	L1200:1125x58x52; L1500:1445X58X52
Packaging Concept	1 in 1 with color box carton box: L1200 12-in-1/ L1500: 8 in 1
Operating Temperature Range (°C)	-20°C to +40°C
Operating Relative Humidity Range (%)	RH(0~90%)
Lifetime Props (LxBy / FR@5000hrs / L80B10-outdoor @ Ta35c)	50K hrs L65/B50 @ Ta 25°C
Approbation	CB / CE

*Data subject to change

Product List

Product Description	Product Type
REVOLVE120 BTN LED40 CW L1200 PSU	33W
REVOLVE120 BTN LED40 NW L1200 PSU	33W
REVOLVE120 BTN LED40 WW L1200 PSU	33W
REVOLVE120 BTN LED60 CW L1500 PSU	50W
REVOLVE120 BTN LED60 NW L1500 PSU	50W
REVOLVE120 BTN LED60 WW L1500 PSU	50W

*Data subject to change

Product Dimensions

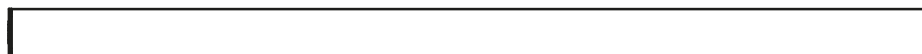



**REVOLVE120
Floodlight**

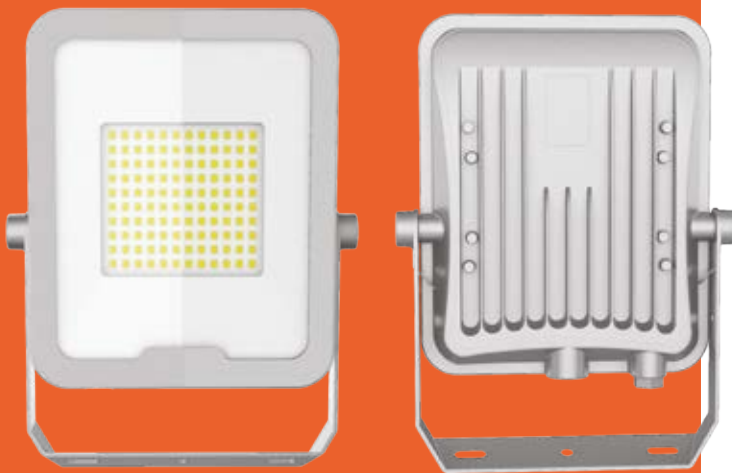

REVOLVE120 Floodlight

Elegant, High Performing & Reliable Floodlights

REVOLVE120 Floodlight range has a compact and sleek design with a 360 degree bracket tilt for application flexibility. The product has symmetrical and asymmetrical light distribution and can be easily installed in a wide range of outdoor general area lighting. This range is integrated with the latest and efficient LED light source with a robust die-cast aluminum housing which is designed to provide consistent light output and last a long lifetime (50,000 hours).

Features and Benefits

Energy Efficient

High efficacy >110 lm/W.

Ideal solution for retrofitting as well as new outdoor installations. Comes with symmetrical & asymmetrical beam angle options.

Easy installation

Bracket has 360° tilt for installation flexibility, comes with flying wire for easy installation.

Slim Profile

Slim and sleek design, compact form factor with light weight & robust quality.

Long Lifetime

Designed to provide consistent light output. Long service lifetime, 50k hrs. (L70B50)

Revolve120 professional floodlight for general outdoor area lighting - perfect solution for open parking lots, industrial areas and recreational sports.



Applications

- Outdoor General Area Flood Lighting
- Open Parking Lots
- Recreational Sports
- Signage
- General Building Facade

High Efficacy

360 Degree Bracket

Slim Profile

Long Service Lifetime

Technical Specifications

	Specifications					
Wattage (W) ±10%	30W	50W	70W	100W	150W	200W
Lumens @ 3000K ±10%	3200	5300	7400	10500	16000	21500
Lumens @ 4000K/6500K ±10%	3400	5700	7800	11300	17000	22500
CRI	≥80					
CCT	3000K, 4000K, 6500K					
SDCM	≤5					
Beam Angle	Symmetric beam: Light pollution : ULR<0%, CIE3 Code > 95%, SWB (100°~120°) Asymmetric beam: Light pollution : ULR<0%, CIE3 Code > 95%, AWB (48° ± 5° x 92° ± 8°)DOB					
Light Distribution	Symmetric wide beam , Asymmetric wide beam					
Input Voltage & Freq.	220V-240V; 50/60 Hz					
Protection Class	Class I (according to IEC 61140)					
Lighting Control Signal Type	PIR sensor (only Symm. WB version)					
Sensor	PIR sensor options for 20W/50W					
Power Factor (System)	> 0.95					
System Efficacy (lm/W) ±10%	> 110lm/W - SWB @4000K					
THD	≤20% PIR sensor version: ≤30% (10W/20W)					
Surge Protection	30W	50W	70W	100W	150W	200W
	2/2KV	2/2KV	4/4KV	4/4KV	4/4KV	4/4KV
IPxx / IKxx	IP65 / IK07 (IK05 sensor)					
Housing Material	Aluminum housing					
Cover Material (Diffuser)	Glass cover					
Mounting	360° orientable U bracket					
Power Connection	Flying cable 3*0.6mm ² , with L/N/G label					
Salt Spray	Standard 500Hrs					
Color(s) (and RAL Code)	Light Grey					
Operating Temperature Range (°C)	-25°C to +40°C					
Lifetime Props	L70B50, 52,000hrs@Ta+55°C					
Approbation	CB , EMC					

*Data subject to change

Product Information

Symmetrical Light Distribution	ASymmetrical Light Distribution	Sensor Versions
REVOLVE120 FLD 30w/830 SYM	REVOLVE120 FLD 30w/830 ASY	REVOLVE120 FLD 20w/830 MDU
REVOLVE120 FLD 30w/840 SYM	REVOLVE120 FLD 30w/840 ASY	REVOLVE120 FLD 20w/865 MDU
REVOLVE120 FLD 30w/865 SYM	REVOLVE120 FLD 30w/865 ASY	REVOLVE120 FLD 50w/830 MDU
REVOLVE120 FLD 50w/830 SYM	REVOLVE120 FLD 50w/830 ASY	REVOLVE120 FLD 50w/865 MDU
REVOLVE120 FLD 50w/840 SYM	REVOLVE120 FLD 50w/840 ASY	
REVOLVE120 FLD 50w/865 SYM	REVOLVE120 FLD 50w/865 ASY	
REVOLVE120 FLD 70w/830 SYM	REVOLVE120 FLD 70w/830 ASY	
REVOLVE120 FLD 70w/840 SYM	REVOLVE120 FLD 70w/840 ASY	
REVOLVE120 FLD 70w/865 SYM	REVOLVE120 FLD 70w/865 ASY	
REVOLVE120 FLD 100w/830 SYM	REVOLVE120 FLD 100w/830 ASY	
REVOLVE120 FLD 100w/840 SYM	REVOLVE120 FLD 100w/840 ASY	
REVOLVE120 FLD 100w/865 SYM	REVOLVE120 FLD 100w/865 ASY	
REVOLVE120 FLD 150w/830 SYM	REVOLVE120 FLD 150w/830 ASY	
REVOLVE120 FLD 150w/840 SYM	REVOLVE120 FLD 150w/840 ASY	
REVOLVE120 FLD 150w/865 SYM	REVOLVE120 FLD 150w/865 ASY	
REVOLVE120 FLD 200w/830 SYM	REVOLVE120 FLD 200w/830 ASY	
REVOLVE120 FLD 200w/840 SYM	REVOLVE120 FLD 200w/840 ASY	
REVOLVE120 FLD 200w/865 SYM	REVOLVE120 FLD 200w/865 ASY	

*Data subject to change



REVOLVE120
All-in-one Solar Streetlight



REVOLVE120 All-in-one Solar Streetlight

All-in-one Solar Luminaire for Road and General Outdoor Lighting

This newly designed Solar All-in-one luminaire is an outdoor lighting product equipped with a microwave motion sensor and has a sleek aluminum design. Available in five different lumen variants and light output up to 17,500 lumens, the Solar AIO can be designed for a wide variety of application areas from road lighting, to perimeter and general outdoor lighting. Its system efficiency is as high as 185lm/W. It is equipped with the state-of-art solar panel with tilt-able bracket option to absorb maximum sunlight and the adjustable design of LED modules ensuring maximum efficacy and light coverage as per requirement.

Features and Benefits

Comprehensive Range for Variety of Applications

Equipped with microwave sensor for automated dimming. Ambient operating temperature T_a 55°C. Adjustable LED modules for maximum coverage and efficacy.

Improve Life at Night With Enhanced Vision

Bringing light to remote off grid locations. Enhancing safety and well-being.

Affordable & Easy To Implement

No cost for electrical infrastructure. Quick and easy to install (all in one) solar lighting solution.

Renewable and Green Energy

100% energy saving using green renewable solar energy source. Universal mounting bracket for maximum sunlight absorption.

Affordable, reliable and sustainable all-in-one solar solution for outdoor and street lighting applications



Applications:

- Outdoor/Garden Area Lighting
- Open Parking Areas
- Walking/Cycling Tracks
- Secondary/Community Roads

Upto 17500 lumens

Upto 185 lm/w

Ta +55°C

Maximum Sunlight Absorption

3G Vibration Resistant

Technical Specification : All-in-One Solar LED Streetlight Upto One Night Backup

	5000 lumen	7200 lumen	9000 lumen	12000 lumen	17500lm
(±5%) Power	27W	40W	50W	67W	95W
Input Voltage	12VDC	12VDC	12VDC	12VDC	24VDC
Control Option	Microwave Sensor				
Photometric Data					
Lens	Polycarbonate (PC)				
Efficacy(lm/w) (±10%)	185 lm/w	180 lm/w	180 lm/w	180 lm/w	185 lm/w
Luminous Flux (lm) (±10%)	5000	7200	9000	12000	17,500
ULOR	= 0%, @ Luminaire Inclination 0°				
CCT	5700K (4000K on request)				
CRI	Ra>=70				
Mechanical Data					
IP Rating	IP65				
IK Rating	IK08				
Housing	Heavy- Duty Die- Cast Aluminum				
Surface Treatment	Anti-UV Thermosetting Polyester				
Housing Color	Standard: Light Grey RAL: 9006 (Dark Grey on Request)				
Mounting	Universal Mounting Bracket				
Solar Panel and Battery Data					
Photovoltaic Panel	Single Side Monocrystalline Solar Panel				
(±5%) Solar Panel	18V/25W	16V/40W	18V/50W	18V/60W	36V/80W
Lithium Ferro Phosphate Battery (LiFePo4)	153.6WH	230.4WH	307.2WH	384.0WH	614.4WH
	12.8V12AH	12.8V18AH	12.8V24AH	12.8V30AH	25.6V24AH
Battery Back Up	One night self support with dimming profile with microwave sensor				
Battery Lifespan	>2000 times cycle				
Ambient Temperature	0°C to +55°C				
Charge Controller	MPPT Intelligent Controller				
Package Info					
Product Size	560*366*133mm	750*366*133mm	910*366*133mm	1080*366*133mm	1345*366*133mm
Net Weight	8.3kg	9.7kg	11.4kg	13kg	16.8kg
Carton Size	820*210*440mm	865*210*440mm	1025*210*440mm	1195*210*440mm	1460*210*440mm
Gross Weight	10.5kg	11.9kg	13.9kg	15.6kg	20kg
Others Specifications					
Lifespan	L70B50, 52,000hrs@Ta+55°C				
Warranty	Standard 3 Year Warranty (5 Years warranty optional)				
Recommend Installation Height	5-8m	5-8m	6-9m	6-10m	8-12m
Application Field	Urban and Rural Street				

*Data subject to change

Dimming Profile (Configurable)

Steps	With Motion Dim	Without Motion Dim	Duration	Occupancy
	Dim	Dim	Hrs	
T1 (Starts at dusk)	100%	30%	2	50%
T2	60%	20%	3	30%
T3	30%	10%	5	30%
T4 (Ends at dawn)	60%	30%	2	50%
	Night Length		12	

Product Information

Product Model	Battery Back Up	Warranty
REVOLVE120 AIO 180S/757 SOLAR 5	1 Night	5 Years (Optional; on request)
REVOLVE120 AIO 120S/757 SOLAR 5	1 Night	5 Years (Optional; on request)
REVOLVE120 AIO 90S/757 SOLAR 5	1 Night	5 Years (Optional; on request)
REVOLVE120 AIO 70S/757 SOLAR 5	1 Night	5 Years (Optional; on request)
REVOLVE120 AIO 50S/757 SOLAR 5	1 Night	5 Years (Optional; on request)
REVOLVE120 AIO 180S/757 SOLAR	1 Night	3 Years
REVOLVE120 AIO 120S/757 SOLAR	1 Night	3 Years
REVOLVE120 AIO 90S/757 SOLAR	1 Night	3 Years
REVOLVE120 AIO 70S/757 SOLAR	1 Night	3 Years
REVOLVE120 AIO 50S/757 SOLAR	1 Night	3 Years

*Data subject to change

Product Dimensions (For One Night Backup)

BRP715 LED50 CW Solar

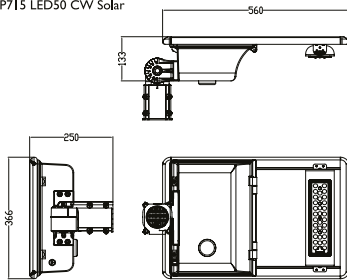

BRP715 LED120 CW Solar

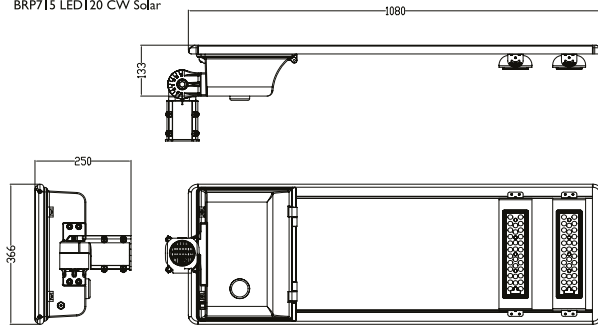

BRP715 LED70 CW Solar

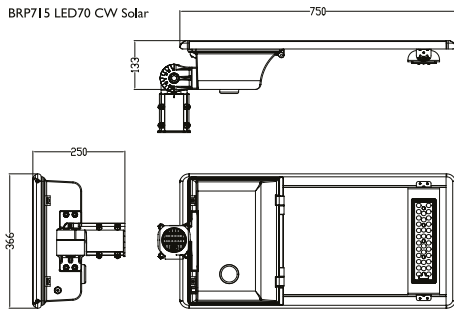

BRP715 LED180 CW Solar

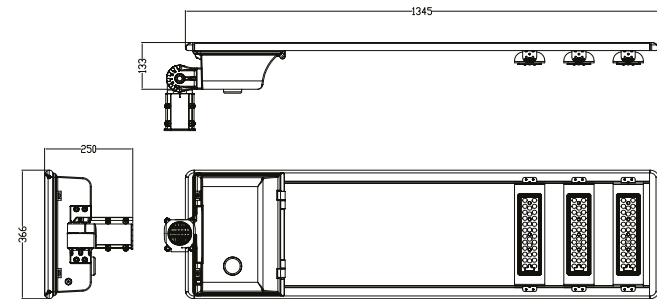

BRP715 LED90 CW Solar

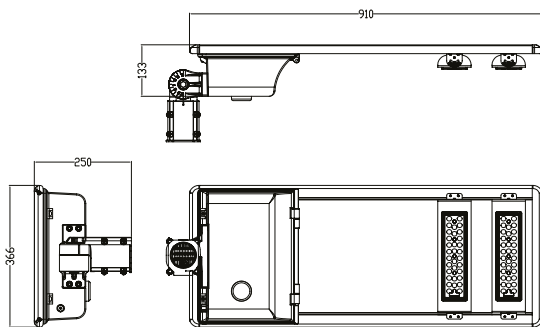

Technical Specification : All-in-One Solar LED Streetlight Upto Two Night Backup

	5000 lumen	7200 lumen	9000 lumen	12000 lumen	17500lm
Power (±5%)	27W	40W	50W	67W	95W
Input Voltage	12VDC	12VDC	12VDC	12VDC	24VDC
Control Option	Microwave Sensor				
Photometric Data					
Lens	Polycarbonate (PC)				
Efficacy (lm/w)(±10%)	185 lm/w	180 lm/w	180 lm/w	180 lm/w	185 lm/w
Luminous Flux (lm)(±10%)	5000	7200	9000	12000	17,500
ULOR	= 0%, @ Luminaire Inclination 0°				
CCT	5700K (4000K on request)				
CRI	Ra>=70				
Mechanical Data					
IP Rating	IP65				
IK Rating	IK08				
Housing	Heavy- Duty Die- Cast Aluminum				
Surface Treatment	Anti-UV Thermosetting Polyester				
Housing Color	Standard: Light Grey RAL: 9006 (Dark Grey on Request)				
Mounting	Unversal Mounting Bracket (17,500 lumens with 2 nights backup is only post top version)				
Solar Panel and Battery Data					
Photovoltaic Panel	Single Side Monocrystalline Solar Panel				
(±5%) Solar Panel	18V/50W	18V/80W	18V/90W	18V/100W	36V/160W
Lithium Ferro Phosphate Battery (LiFePo4)	384.0WH 12.8V30AH	537.6WH 12.8V42AH	614.4WH 12.8V48AH	844.8WH 12.8V66AH	1228.8WH 25.6V48AH
Battery Back Up	Two nights self support with dimming profile with microwave sensor				
Battery Lifespan	>2000 Times Cycle				
Ambient Temperature	0°C to +55°C				
Charge Controller	MPPT Intelligent Controller				
Package Info					
Product Size	910*366*133mm	1345*366*133mm	1535*366*133mm	1670*366*133mm	1812*522*133mm
Net Weight	11.6 kg	15 kg	16.8 kg	23.8 kg	35.9 kg
Carton Size	1025*210*440mm	1460*210*440mm	1650*210*440mm	1790*210*440mm	1930*600*200mm
Gross Weight	14.1 kg	18.1 kg	20.7 kg	27.7 kg	40.3 kg
Others Specifications					
Lifespan	L70B50, 52,000hrs@Ta+55°C				
Warranty	Standard 3 Year Warranty (5 Years warranty optional)				
Recommend Installation Height	5-8m	5-8m	6-9m	6-10m	8-12m
Application Field	Urban and Rural Street				

*Data subject to change

Dimming Profile (Configurable)

Steps	With Motion Dim		Without Motion Dim		Occupancy
	Dim	Hrs	Dim	Hrs	
T1 (Starts at dusk)	100%	3	50%	3	50%
T2	50%	3	40%	3	30%
T3	50%	4	30%	4	30%
T4 (Ends at dawn)	50%	2	30%	2	50%

Product Information

Product Model	Battery Back Up	Warranty
REVOLVE120 AIO 180S/757 SOLAR PRO 5	2 Night	5 Years (Optional; on request)
REVOLVE120 AIO 120S/757 SOLAR PRO 5	2 Night	5 Years (Optional; on request)
REVOLVE120 AIO 90S/757 SOLAR PRO 5	2 Night	5 Years (Optional; on request)
REVOLVE120 AIO 70S/757 SOLAR PRO 5	2 Night	5 Years (Optional; on request)
REVOLVE120 AIO 50S/757 SOLAR PRO 5	2 Night	5 Years (Optional; on request)
REVOLVE120 AIO 180S/757 SOLAR PRO	2 Night	3 Years
REVOLVE120 AIO 120S/757 SOLAR PRO	2 Night	3 Years
REVOLVE120 AIO 90S/757 SOLAR PRO	2 Night	3 Years
REVOLVE120 AIO 70S/757 SOLAR PRO	2 Night	3 Years
REVOLVE120 AIO 50S/757 SOLAR PRO	2 Night	3 Years

*Data subject to change

Product Dimensions (For Two Night Backup)

BRP715 LED50 CW Solar Pro

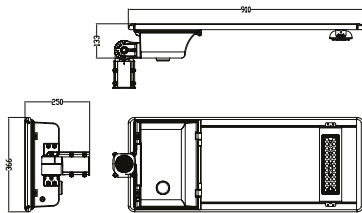

BRP715 LED120 CW Solar Pro

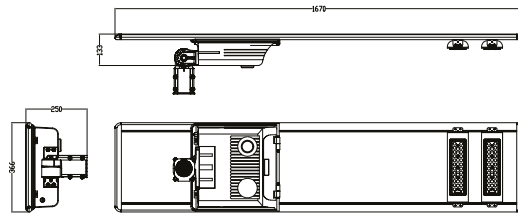

BRP715 LED70 CW Solar Pro

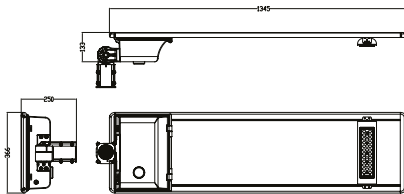

BRP715 LED180 CW Solar Pro

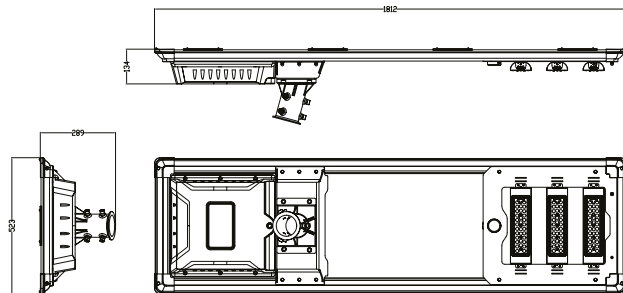

BRP715 LED90 CW Solar Pro

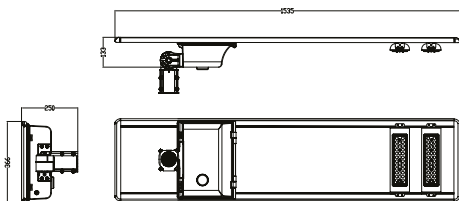



**REVOLVE120
Waterproof Luminaire**



REVOLVE120 Waterproof Luminaire

Efficient and Durable Solution for Parking and Industrial Applications

Revolve120 WPL series is an energy efficient industrial waterproof fixture that features rugged design and durable construction. Revolve120 WPL series is suitable for dust-proof and waterproof applications and can be installed as surface or suspension mounted. With high delivered efficiency of $> 110\text{lm/W}$ and $\leq 135\text{lm/W}$ & professional light distribution, luminaire is able to achieve high-quality lighting effect with excellent energy savings.

Features and Benefits

Robust Design

Dustproof and waterproof body IP65 rating with high impact resistant IK08. UV resistant polycarbonate material front cover.

Extensive Product Range

03 length options (L600, L1200, L1500 mm) for variety of applications. High color rendering $\text{CRI}>80$, high energy-saving with completely diffused light output and delivered efficacy $>110\text{lm/W}$.

Reliable Quality

50,000 hours life @ L65B50, slim profile design for excellent aesthetics. Suitable for parking, a variety of industrial applications and semi-outdoor applications

Easy Installation

Stainless steel brackets for front cover opening, easy maintenance & installation. Replaceable driver option for long term maintenance.

REVOLVE120 waterproof luminaire designed for parking areas, warehouse and industrial applications

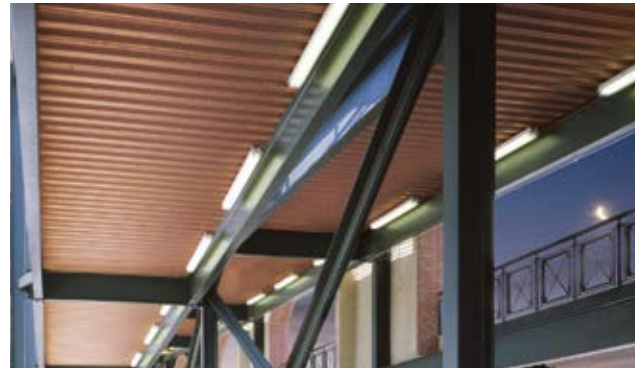

Applications

- Industry
- Warehouse
- Parking
- Dust-proof and Water-proof
- Environments

Robust Design (IP65/IK08)

Energy Efficient

Diffused Light Output

Extensive Product Range

Technical Specifications

	2 ft.	4 ft.	5 ft.
Lumen Output (Typ.Avg) ±10%	1800 lm	2500lm/4900lm	3600lm/7000lm
Power Consumption (System) ±10%	16 W	22W/44W	31W/53W
System Efficacy ±10%	>110lm/W	>110lm/W	>110lm/W
CRI		≥80	
CCT		4000K, 6500K	
SDCM		≤ 6	
Uniformity		Diffused Light Output	
Beam Angle		100°-120 °	
Input Voltage		220-240 V	
Frequency		50/60Hz	
Safety Class (Driver+System)		Class I	
Power Factor (System)		>0.9	
Surge Protection (D/C)		1/2kV	
Housing Material		Housing - P olycarbonate, clips - 301 Stainless Steel	
Cover Material (Diffuser)		PC, UV Resistant	
IPxx		IP65	
IKxx		IK08	
Salt Spray		72 Hrs included accessories	
Glow Wire Rating		850°C 30 Sec	
Power Connection		Push in Connector	
Through Wiring		No	
Loop in Capacity		Yes (upgrade provision available) + Knockout option on top and both sides	
Color(s)		Cover - White opal; Housing : Grey RAL7038	
Size (LxWxH) + Considerations	L600 : 600*71*74mm	L1200: 1200*71*74mm	L1500: 5FT: 1500*71*74mm
Weight (Kg)	L600: 0.75kg	L1200: 1.15kg	L1500: 1.4kg
Packaging Concept		Unit carton: 1in1, Brown box Master Carton: 9 in1	
Operating Temperature Range		-20C to +40C for PSU	
Lifetime		50Khr L65B50 @Ta 25C	
Default Mounting Accessories		2 x bracket, 4 x (screws+expansion bolt), 2 pcs screws for clips	

*Data subject to change

Product List

Product Range	Product Type
REVOLVE120 WPL LED18S/840 PSU L600	2 feet
REVOLVE120 WPL LED25S/840 PSU L1200	4 feet
REVOLVE120 WPL LED49S/840 PSU L1200	4 feet
REVOLVE120 WPL LED49S/865 PSU L1200	4 feet
REVOLVE120 WPL LED36S/840 PSU L1500	5 feet
REVOLVE120 WPL LED70S/840 PSU L1500	5 feet
REVOLVE120 WPL LED70S/865 PSU L1500	5 feet

*Data subject to change



**REVOLVE120
Bulkhead Luminaire**



REVOLVE120 Bulkhead Luminaire

Robust Wall & Ceiling Mounted Luminaire

REVOLVE120 wall mounted/ceiling mounted luminaires are a sustainable and reliable offering for indoor spaces with IP65 ingress protection. The product offers two lumen packs and are suitable for versatile applications such as staircases, industrial areas, lift walls etc. The product comes with excellent aesthetics and is dust-proof, UV resistant and water-proof making it a direct replacement of traditional luminaires. The REVOLVE120 bulkhead has an efficacy of up to 100lm/W with a high lifetime of 50,000 hours.

REVOLVE120 ceiling mounted and wall mounted luminaire for dust-proof and water-proof applications and back-of-house area lighting needs.



Applications

- Staircases
- Back of House Areas
- Outdoor Covered Spaces
- Industrial Applications
- Utility Rooms

Features and Benefits

Variety of Applications

285 mm diameter and slim profile design with simple installation suitable for back of house areas and industrial applications.

Sturdy Housing Body

The product is waterproof (IP65) and vandal-proof (IK08) with excellent aesthetics and slim profile design.

Comprehensive Range

Bulkhead comes in 02 lumen packages with an optional integrated sensor option for wireless motion detection (MDU).

Energy Efficient and Long Lifetime

Long lifetime of 50,000 hours with improved efficacy of up to 100lm/W.

Intelligent/ Motion Sensor Option

UV Resistant Front Cover

IP65 Rating

Uniform Brightness

Technical Specifications

	Specifications
Lumen Output (typ.Avg) (lm) ±10%	1050lm @3000K (11W) / 1100 lm@4000k (11W) 1615lm @3000K (17W) /1700lm@4000K (17W) PSU+MDU: 1700lm (19W)
CRI	>80
CCT	3000K, 4000K
SDCM	<5
Beam Angle	120°
Input Voltage and Frenquency	220-240V ; 50/60Hz
Protection Class	Class II
Lighting Control Signal Type	PSU+MDU: Micro-Wive
Power Factor (System)	>0.9
Power Consumption (System) ±10%	PSU: 11W / 17W PSU+MDU: 19W
System Efficacy (lm/W)	PSU: >100lm/W@4000K PSU+MDU: >85lm/W
THD	<20%
Surge Protection	PSU: 2KV PSU+MDU: 1KV
Housing Material	Polycarbonate
Cover Material (Diffuser)	Polycarbonate Outdoor Operation and UV -Resistance
IPxx	IP65
IKxx	IK08
Type of Connector	Terminal Connection
Power Connection	Push-In Terminal Block
Through Wiring	Reserve 2 Hole Provisions on Housing for Power In and Power Out
Cable	2x1.0mm2-2x1.5mm2, D6-D10
Color(s) (and RAL Code)	RAL9003
Size (LxWxH) + Considerations	D285x64±2mm
Operating Temperature Range (°C)	-20°C to +40°C
Lifetime	L70B50, 52,000hrs@Ta+55°C

*Data subject to change

Product List

Product Description	Product Type
REVOLVE120 BHD 17S/840 WH MDU	Integrated Sensor Version
REVOLVE120 BHD 17S/830 WH MDU	Integrated Sensor Version
REVOLVE120 BHD 17S/840 WH	Standalone
REVOLVE120 BHD 17S/830 WH	Standalone
REVOLVE120 BHD 11S/840 WH	Standalone
REVOLVE120 BHD 11S/830 WH	Standalone

*Data subject to change



REVOLVE120 Highbay



REVOLVE120 Highbay

LED Highbay Luminaire

REVOLVE120 Highbay is an energy efficient and reliable LED luminaire with a powerful light output which is suitable to achieve lighting needs for warehouse, industry and high ceiling applications. Designed for point to point replacement of conventional HPI 250W/400W luminaires, it offers the benefit of energy efficiency, less maintenance and longer lifetime of 50,000 hours. The product has high CRI (>70) for better visual effect in industrial applications.

Features and Benefits

Energy Efficient

High efficacy upto 115 lm/W.

Ideal solution for retrofitting as well as new installations.

Easy Installation

Compact and light weight, comes with mounting hook for easy installation.

Slim Profile

Excellent aesthetics, round shape slim profile luminaire comes in 3 sizes with max dia. of 300mm.

Long Lifetime

Designed to provide consistent light output. Long service lifetime, 50k hrs. (L65B50)

REVOLVE120 Highbay for warehouse, industries and high ceiling lighting needs



Applications

- Warehouse
- Industry
- Medium & High Ceiling Installations

IP65 Water Resistant

Wide Beam Angle 110°

Up to 22,500lm

Slim Profile & Light Weight

Technical Specifications

	Specifications
Lumen Output (Typ.Avg)(lm)(+5%,-10%)	11,500lm, 17,000lm, 22,500lm
CCT	CW 6500K
CRI	>=70
Beam Angle	WB (110°) ±10%
Input Voltage and Frequency	220-240V; 50/60Hz
Protection Class	Class I
Fuse or Short-Circuit Protection	Fuse
Power Factor (System)	>0.9
Power Consumption (System)(+2.5%, - 10%)	100W, 150W, 200W
System Efficacy (lm/W)(+5%,-10%)	up to 115lm/W @ 4000k
THD	<20%
Surge Protection	1k/2kV
Housing Material	Aluminum die-casting
IPxx	IP65
IKxx	IK06
Mounting	Suspension, GM-M10 Hook included
Power Connection	Flying Cable (0.3meter)
Color(s) and RAL Code	Black RAL9005
Size (LxWxH) + Considerations	100W: φ220*H50, 150W: φ260*H53, 200W: φ300*H54
Packaging Concept	Industry Package; 1 in one box
Operating Temperature Range (°C)	-20°C to +40°C
Lifetime Props (LxBy/FR@5000 Hrs/ L80B10-Outdoor @ Ta35C)	50,000 Hrs (Calculated L65B50)
Approbation	CB/EMC

*Data subject to change

Product List

Product Description	Product Type
REVOLVE120 HBY 100w/765	100W
REVOLVE120 HBY 150w/765	150W
REVOLVE120 HBY 200w/765	200W

*Data subject to change

REVOLVE



Signify International B.V. (Middle East Office)
Dubai Knowledge Village, Al Sufouh 2
P.O Box 5653, Dubai United Arab Emirates